

- Mit zwei fest montierten Rädern ausgestattet, leicht zu bewegen.
- Gitter problemlos austauschbar.
- Kein elektrischer Anschluss erforderlich.
- Magnetischer Mehlbehälter.
- Geringer Platzbedarf.
- Platzsparende Unterbringung für 4 Gitter.
- Mit Teigteilwanne und 2 Gitter ausgestattet.
- Manuelles Teilen und Formen des Teiges.





- Montado sobre dos ruedas fijas, fácil de mover.
- Parrillas de corte fácilmente intercambiables.
- No es necesaria conexión eléctrica.
- Caja magnética para la harina.
- Ocupa poco espacio.
- Almacenaje de 4 parrillas.
- Equipado con un contenedor divisor y 2 rejillas de corte.
- Cortado y moldeado manual de la pasta.

- Facile da spostare grazie alle due rotelle fisse.
- Griglie facilmente intercambiabili.
- Non richiede collegamenti elettrici.
- Cestino magnetica per farina.
- Ingombro ridotto.
- Spazio per 4 griglie.
- Dotata di vasca di divisione e 2 griglie.
- Divisione e formatura manuali.



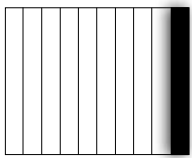
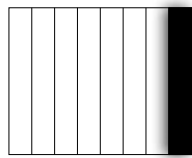
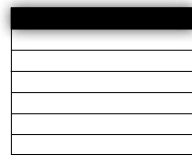
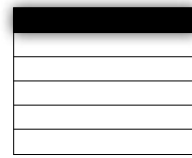



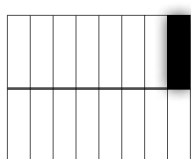
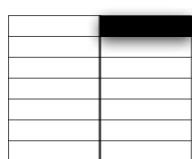
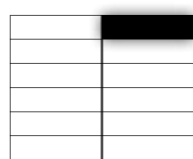
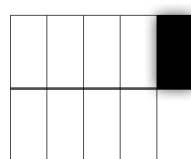
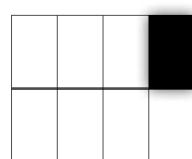

KUNSTSTOFFGITTER | PARRILLA EN PLÁSTICO | GRIGLIA IN PLASTICA

Einfache Teilung | división simple | Divisione semplice

			
			
MSG101001P	MSG080801P	MSG070107P	MSG060106P
10 (10 x 1)	8 (8 x 1)	7 (1 x 7)	6 (1 x 6)
180 - 500 gr	225 - 625 gr	255 - 710 gr	300 - 830 gr
30 x 334 mm	41 x 334 mm	454 x 47 mm	454 x 54 mm

Doppelte Teilung | Doble división | Divisione doppia



					
					
MSG201002P	MSG160802P	MSG140207P	MSG120206P	MSG100502P	MSG080402P
20 (10 x 2)	16 (8 x 2)	14 (2 x 7)	12 (2 x 6)	10 (5 x 2)	8 (4 x 2)
90 - 250 gr	110 - 310 gr	125 - 355 gr	150 - 415 gr	180 - 500 gr	225 - 625 gr
30 x 160 mm	41 x 160 mm	224 x 45 mm	224 x 54 mm	155 x 80 mm	155 x 105 mm

Gitter mit profilierten Messern:
 Profiliertes Messer aus POM-Kunststoff, für
 Nahrungsmittel geeignet, für ein
 ausgezeichnetes verschließen des Teiges bei der
 Teigteilung.

Parrillas con cuchillas perfiladas:
 Cuchillas perfiladas de polioximetileno,
 aptas para uso comestibles, para una
 soldadura perfecta de la masa mientras la
 división.

Griglie con lame sagomate:
 Lame sagomate di polioossimetilene,
 idonee per l'uso di alimenti, per una
 saldatura perfetta della pasta nella
 divisione.

GITTER AUS EDELSTAHL | PARRILLA EN ACERO INOX | GRIGLIA IN ACCIAIO INOSSIDABILE





MSG060601

6 (6 x 1)

300 - 1000 gr

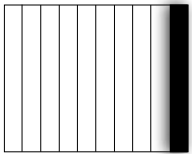
73 x 334 mm





MSG080801

8 (8 x 1)

225 - 750 gr

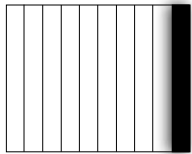
54 x 334mm





MSG101001

10 (10 x 1)

180 - 600 gr

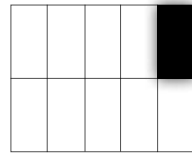
42 x 334 mm





MSG100502

10 (5 x 2)

180 - 600 gr

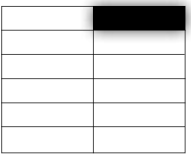
88 x 160 mm





MSG120206

12 (2 x 6)

150 - 500 gr

224 x 53 mm





MSG120403

12 (4 x 3)

150 - 500 gr

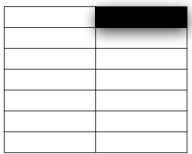
115 x 108 mm





MSG140207

14 (2 x 7)

125 - 425 gr

224 x 47 mm





MSG200504

20 (5 x 4)

90 - 295 gr

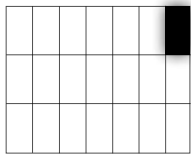
87 x 80 mm





MSG210703

21 (7 x 3)

85 - 285 gr

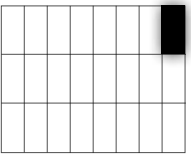
62 x 108 mm





MSG240803

24 (8 x 3)

75 - 250 gr

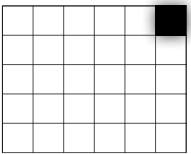
57 x 108 mm





MSG300605

30 (6 x 5)

60 - 200 gr

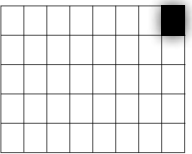
73 x 64 mm





MSG400805

40 (8 x 5)

45 - 125 gr

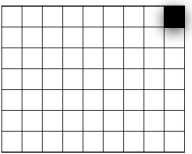
54 x 64 mm





MSG630907

63 (9 x 7)

25 - 63 gr

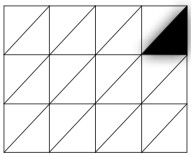
47 x 45 mm

MSG240403/2

24 (4 x 3) x 2

75 - 165 gr

115 x 108 x 150 mm

Gewicht und Abmessungen können je nach Teigart variieren. ■ El peso y las dimensiones pueden variar según el tipo de masa. ■ Peso e dimensioni possono variare a seconda del tipo di impasto.



- Gitter problemlos austauschbar.
Parrilla de corte fácilmente intercambiables.
- Griglie facilmente intercambiabili.

- Magnetischer Mehlbehälter.
Contenedor magnético para la harina.
- Contenitore magnetico per farina.

- Herausziehbare Halterung für die Teigteilwanne.
Apoyo extraíble para el contenedor de división.
- Supporto estraibile per il cestello di divisione.



- Unterbringung für 4 Gitter.
Almacenaje para 4 parrillas.
- Spazio per 4 griglie.



- Option: Blechwagen
Opción: carro para contenedores
- Opzione: carrello per teglie

Teigwanne Cubetas Recipienti	14
Deckel Tapas Coperchi	14
Kapazität Capacidad Capacità	9,8 L (5 - 6 kg)

SEITENANSICHT | PERFIL | VISTA LATERALE

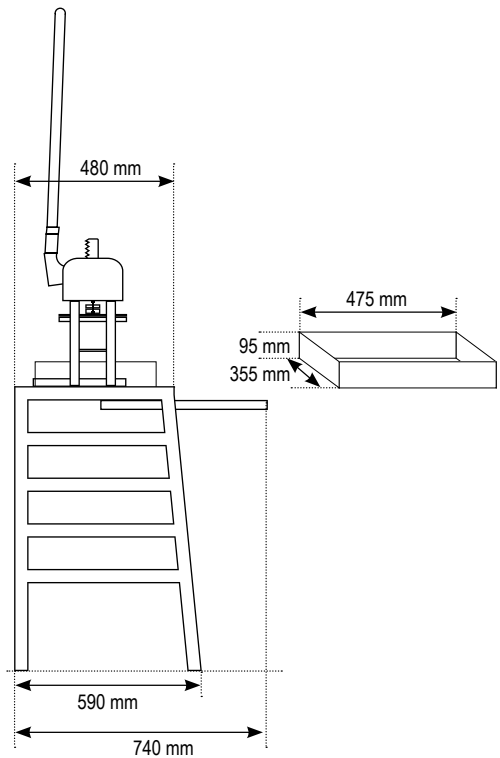

VORDERANSICHT | ALZADO | VISTA FRONTEALE

